

NOTE(S):
 1. PART NUMBER, "/00" DENOTES PART SHALL HAVE FINISH.

2. APPLY NSF COMPLIANT GREASE TO ANY O-RING, SEALING JOINTS, AND/OR PIVOTAL POINTS. G

3. APPLY NSF COMPLIANT LOCTITE TO THREADED AREA. L

4. APPLY NSF COMPLIANT REMOVABLE (BLUE) LOCTITE TO THREADED AREA. B

5. SILVER SOLDER JOINTS SHALL BE FULLY WETTED VIA CAPILLARY ACTION AND COMPLETELY NON-POROUS. S

ITEM NO.	PART NUMBER	DESCRIPTION	QTY.
1	3-420/00	WALL TUB, SPOUT ONLY, 12" L, BASIC	1
1.1	P19017/00	ESCUTCHEON, FOR SPOUT	1
1.2	90119	O-RING, 15/16"ID X 1-1/8"OD X 3/32"THK, AS-568-119	1
1.3	90129	O-RING, 1-9/16"ID X 3/32"THK, AS-568-129	1
1.4	10480/00	12" WALL LAV SPOUT, BASIC SERIES	1
1.5	P05024	AERATOR CACHE COIN SLOT, M21.5X1.0 FULL FLOW	1
2	3-580/00	HANDLE CROSS W/ SET SCREW, TRANSITION	2
3	3-590/00	ESCUTCHEON W/ SET SCREW, TRANSITION	2
4	11003	SLEEVE MOUNT, WALL MT WIDESPREAD	2
5	90029	O-RING, 1-5/8"ID X 1-3/4"OD X 1/16"THK, AS-568-029	2

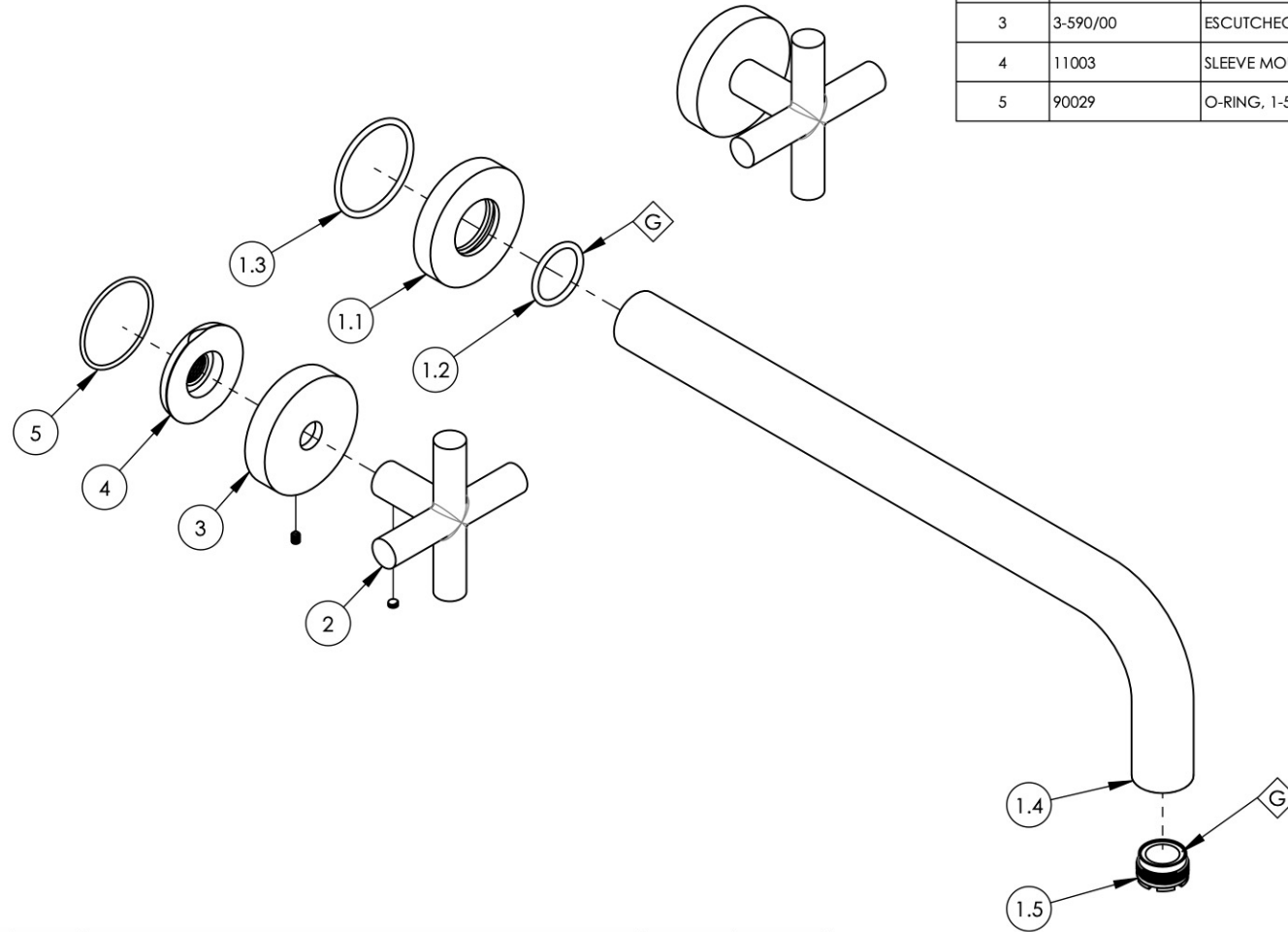

ZONE	REV.	DESCRIPTION	DATE	APPROVED
REVISIONS				

1261 LOGAN AVENUE
 COSTA MESA, CALIFORNIA 92626
 PHONE: 714.361.4800
 FAX: 714.617.3120

PHYLIRICH[®]
 Defining Luxury Since 1959

PROPRIETARY AND CONFIDENTIAL
 THE INFORMATION CONTAINED IN THIS DRAWING IS THE SOLE PROPERTY OF PHYLIRICH. ANY REPRODUCTION IN PART OR AS A WHOLE WITHOUT THE WRITTEN PERMISSION OF PHYLIRICH IS PROHIBITED.
DO NOT SCALE DRAWING

WALL TUB SET, 12" SPOUT, CROSS HANDLES, TRANSITION

SIZE A	ASM/PRT NO. 120-56-12/00	REV -
SCALE: 1:3	WEIGHT: lbs.	SHEET 1 OF 2